

0V-100V, 0V-200V BYH Series

BYH Series is an Ultra-Small size High Voltage DC-DC Converter which store 0V-100V or 0V-200V output power supply in 24pin-IC case. We have reduced the size to 1/3 to 1/4 of latest high voltage technology power supply by SMT (Surface Mounting technology). Output voltage of all BYH series is adjustable from 0V by external voltage.

<Features>

- Achieved 24pin IC Size
- Output Voltage 0-100V, 0-200V
- Output Power 0.2W
- Over-Current Protection
- Ultra Small Size
- Low Price
- 5-Side Metallic Shield Case
- Low Ripple Noise 10mVp-p
- Burn-in Testing 100% practised
- Adjustable Voltage by External Voltage
- Isolation Voltage DC250V
- High Reliability, Long Life

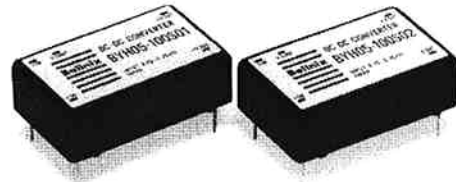

<Model, Rating>

Model	Input Voltage (Vdc)	Output Voltage (Vdc)	Output Voltage Adjustable Range (Vdc)	Output Current (mA)	Output Power (W)	Input Current (mA) typ	Ripple/ Noise (mVp-p) typ
BYH05-100S02	4.75 - 5.25	100 ± 4%	0 - 100	0 - 2	0.2	90	10
BYH12-100S02	11.0 - 16.0	100 ± 4%	0 - 100	0 - 2	0.2	34	10
BYH05-200S01	4.75 - 5.25	200 ± 4%	0 - 200	0 - 1	0.2	98	10
BYH12-200S01	11.0 - 16.0	200 ± 4%	0 - 200	0 - 1	0.2	41	10

<Specification>

Line Regulation	0.3% typ. (For the regulation of input voltage 4.75V-5.25V or 11.0V-16.0V, at rating load)
Load Regulation	8% typ. (For the regulation of load 0%-100%, at rating input voltage)
Temp. Coefficient	±0.5% typ. (For the regulation of operating temp. range -10°C to 50°C)
Over-Current Protection	Operates at 105% or more, Built-in Auto-recovery Circuit
Output Voltage Setting Accuracy	±4% max. (Rating output, Rating load, at Vcont 3.0V or 10.0V)
Output Voltage Control (1)	BYH05 Series : Controlable at external voltage 0V-3V (Refer to application)
Output Voltage Control (2)	BYH12 Series : Controlable at external voltage 0V-10V (Refer to application)
Operating Temp. Range	-10°C to 60°C (Temp. Derating required from 50°C)
Storage Temp. Range	-25°C to 85°C
Operating Humidity Range	20% to 95%RH (non condensing)
Isolation Voltage	Between primary and secondary DC250V; for 1min (Continuous Voltage : DC250V)
Isolation Resistance	Between primary and secondary 100M ohm min. (DC500V)
Floating Output	Floating output upto voltage of DC250V
MTBF	1,400,000H

Note 1: Output voltage is controlled by Vcont voltage. Please control the output voltage by impressing external voltage to Vcont pin. When Vcont voltage = 0V, output voltage is within 0.5% of the maximum output voltage (Rating Input).

<Test Circuit>

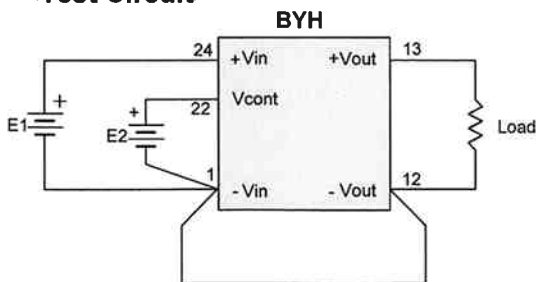

BYH05 Series: E1=4.75V-5.25V, E2=0V-3V
 BYH12 Series: E1=11.0V-16.0V, E2=0V-10V

<Block Diagram>

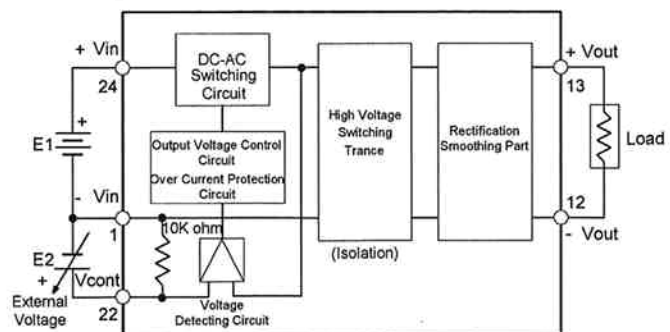

<Outline>

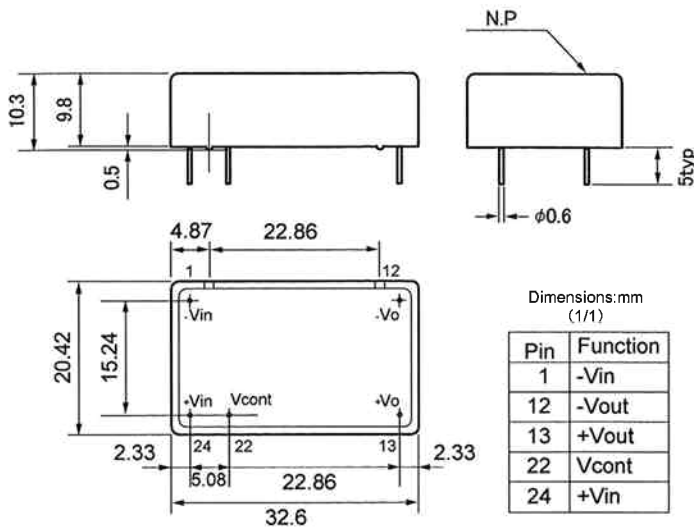

<Standard Usage>

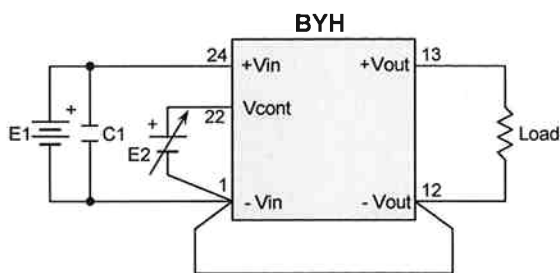

Bellnix High Voltage converters do not basically require additional parts but in case the input impedance is high as the long distance between input power supply and converter, thin input line, filter composed at input line, please add capacitor C1 at the input side. please mount the capacitor close to the converter pin and lower the lead inductance.

<Over-Current Protection >

This product has a built-in over-current protection to prevent from over load and load short. In case when over load and load short occur, output will actuate by descending the output voltage and will automatically recover by eliminating the cause.

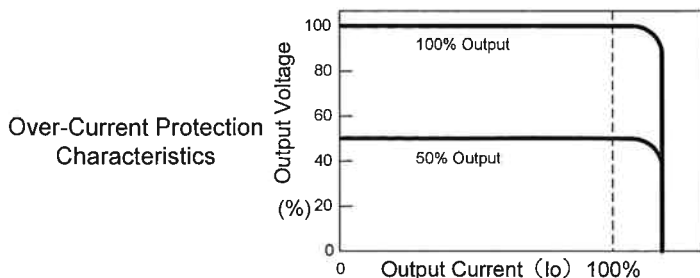

<Adjusting Output Voltage>

Output voltage of BYH series can be adjusted by external voltage.

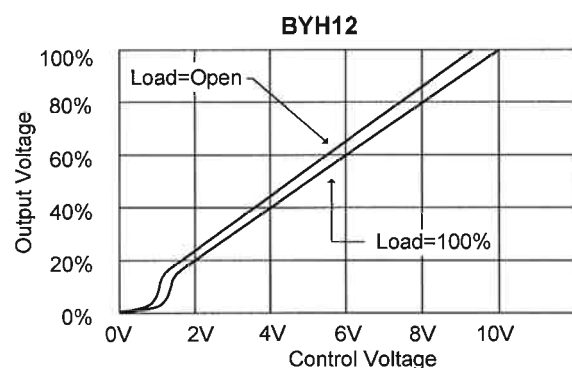
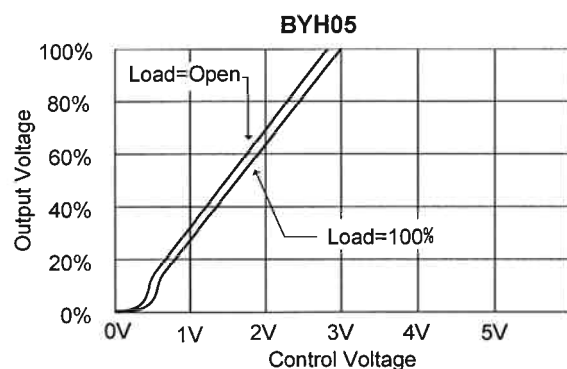
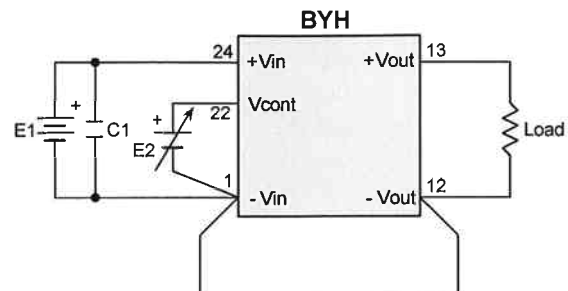

- Please do not impress more than Vcont max. +10% when impressing to Vcont.
- Please connect common of external control voltage to -Vin (1Pin).
- Please be careful. Regulation and ripple noise of Vcont pin influence the output.

<Recommended pattern>

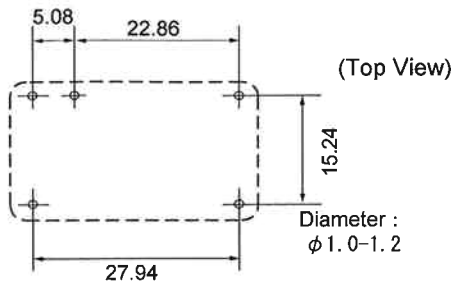

1. BYH Series is covered by metallic case. When mounting to double-side PWB, please wire at soldering side. This converter generate high voltage. Please be careful with the creeping distance of the pattern when wiring.
2. When mounting to the double-side PWB, please make the land of part side of high voltage output pin as small as possible.
3. There is no need to earth the metallic case. When metallic case is required earthing, please lower the impedance between the ground and the metallic case.

<Temperature Derating>

When using above 50°C of ambient temp., please use within below shown derating.

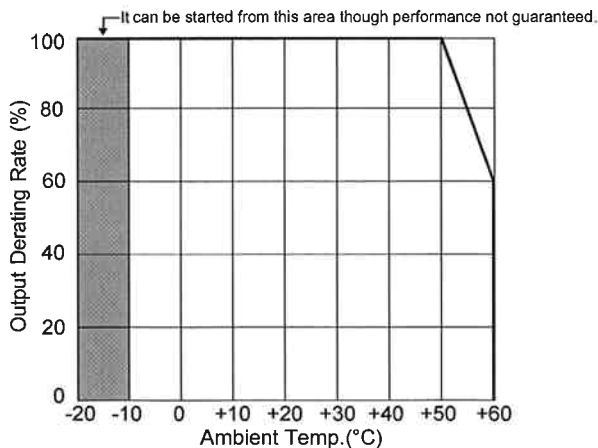

<To prevent reverse input voltage>

The converter may be damaged if the input voltage is connected reversly. If there is any possibility of reverse connection, please connect diode and fuse to input pin as shown below.

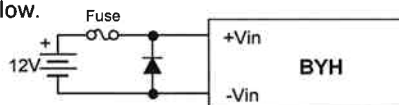

<Recommended Soldering Conditions>

Solder to be executed under the following conditions.

1. Soldering iron 340 to 360°C within 5sec.
2. Soldering dip 230 to 260°C within 10sec.

<Method to lower the output noise>

BYH series do not basically need the additional part though to lower the output noise furthermore, it is recommended to add capacitor C2 as below.

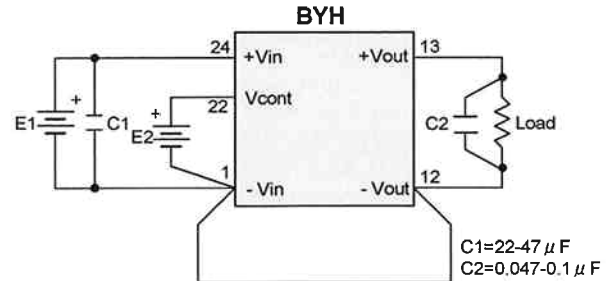

To lower the output noise furthermore, wire input/output line as thick and short as possible and layout C2 near the load by watching out the creeping distance and clearance distance.

The Points

1. For capacitor to add for input, please select the part which is good in high-frequency characteristics.
2. Please design the common line as thick and short as possible in order to make common impedance small.
3. When adding capacitor at load side, please add near the load side and confirm it will take enough rated voltage. Please contrive to shorten the lead of the capacitor. Please be careful about the time constant with the capacitor if load which speed of response would become problem.

<Guarantee>

This product shall be guaranteed for one year. During this period, if there should be any failure definitely due to our designing or manufacturing workmanship, we will repair or replace it with new one at our own expense. But in case that it should be modified and/ or made internal remodeling by buyer itself whatsoever, we can guarantee it. This guarantee shall cover only BYH series.

<Contact Bellnix>

For further information of this product, please contact to the number below.
TEL:81-48-864-7733

Bellnix®

Bellnix Co.,Ltd.
5-7-8 Negishi Minami-ku, Saitama-shi,
SAITAMA, JAPAN 336-0024
TEL : 048-864-7733 FAX : 048-861-6402
E-mail:info@bellnix.co.jp
http://www.bellnix.co.jp/

*All specification are subject to change without notice.

PRINTED IN JAPAN BDD20060529

VISTAS GmbH

Freisinger Str. 13 • 85737 Ismaning
Tel.: 089 / 92 92 80 90 • Fax: 089 / 92 92 80 99
Internet: www.vistas-gmbh.de

Imaging:

- CCD/CMOS Sensorik
- CCD/CMOS Digitalkameras
- EM-CCD Kameras
- Modulare Kameraelektronik
- Kamerazubehör
- LED Beleuchtungen
- 1394B to PCIe Boards

Biometrie:

- USB Fingerprint Reader
- OEM Fingerprint Module
- Fingerprint Terminals
- RFID / E-Pass

Kundenspezifische Lösungen
DC/DC Converter

AN Fax-Nr.: 089 92 92 80 99

Firma: _____

Name: _____

Adresse: _____

Email: _____

Telefon: _____

FAX: _____

Ich wünsche folgende DC-DC Wandler zur Bemusterung:

Typ: _____

Menge: _____

Alternativprodukt: _____

Unser Serienbedarf:

Menge/Jahr: _____

Ab Monat/Jahr: _____

Preisangebot gewünscht: Ja / Nein

Typ _____ Mengen _____

Typ _____ Mengen _____

Typ _____ Mengen _____

Typ _____ Mengen _____